









Unit Specification		
	3.1m x 1.5m x 2.2m	
	0.9m	
	145kg	
	20kg	
	1.8m x 0.5m x 0.5m	
	1.8m	
	1 in 50	
	6.7m x 5.1m x 3.4m	
	2	
	9 hours	
	0.5m <sup>3</sup>	
	0.6m <sup>3</sup> (Surface Fixed)	

Plastic Slide

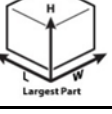
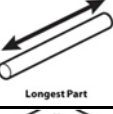
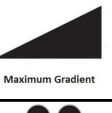
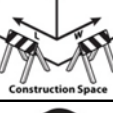

A = 300 (w) X 300 (l) X 600 (d)  
B = 300 (w) X 300 (l) X 400 (d)

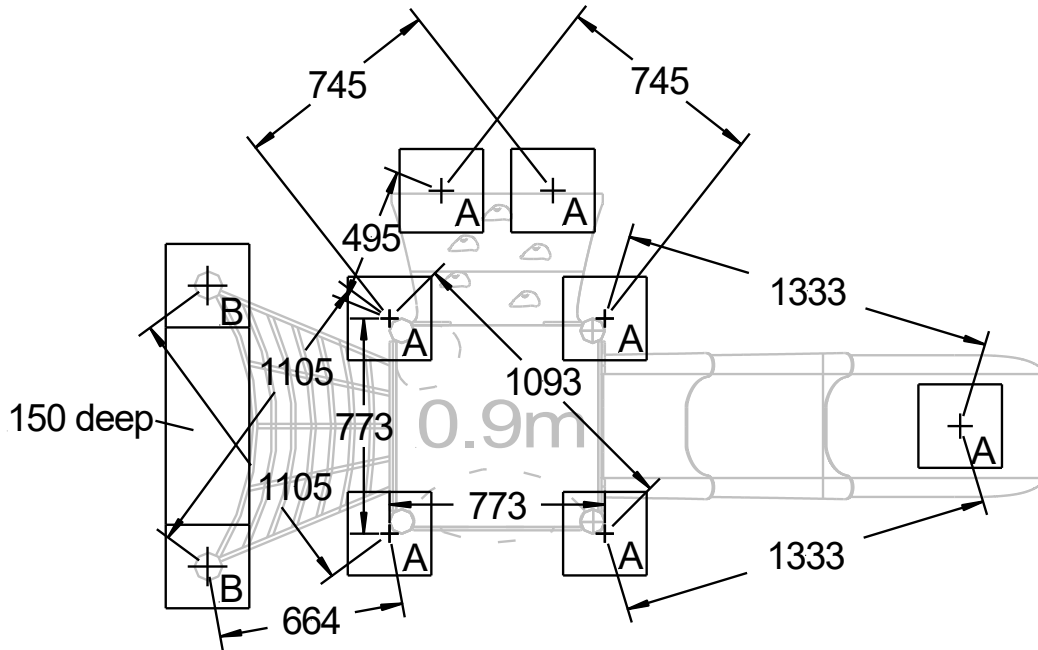
Stainless Steel Slide

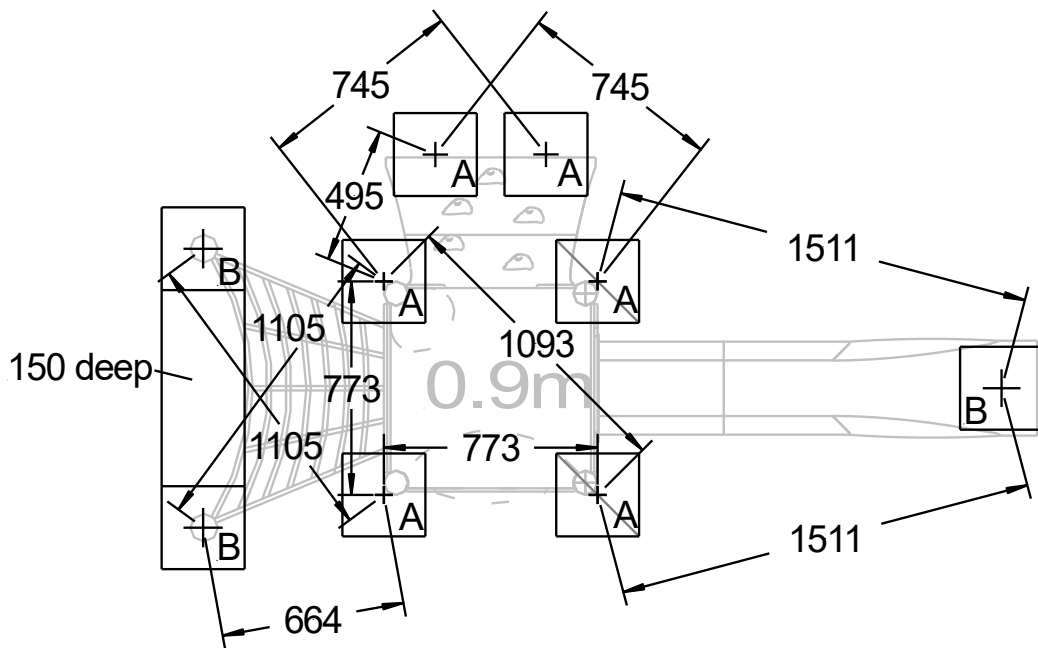

A = 300 (w) X 300 (l) X 600 (d)  
B = 300 (w) X 300 (l) X 400 (d)

Plastic Slide

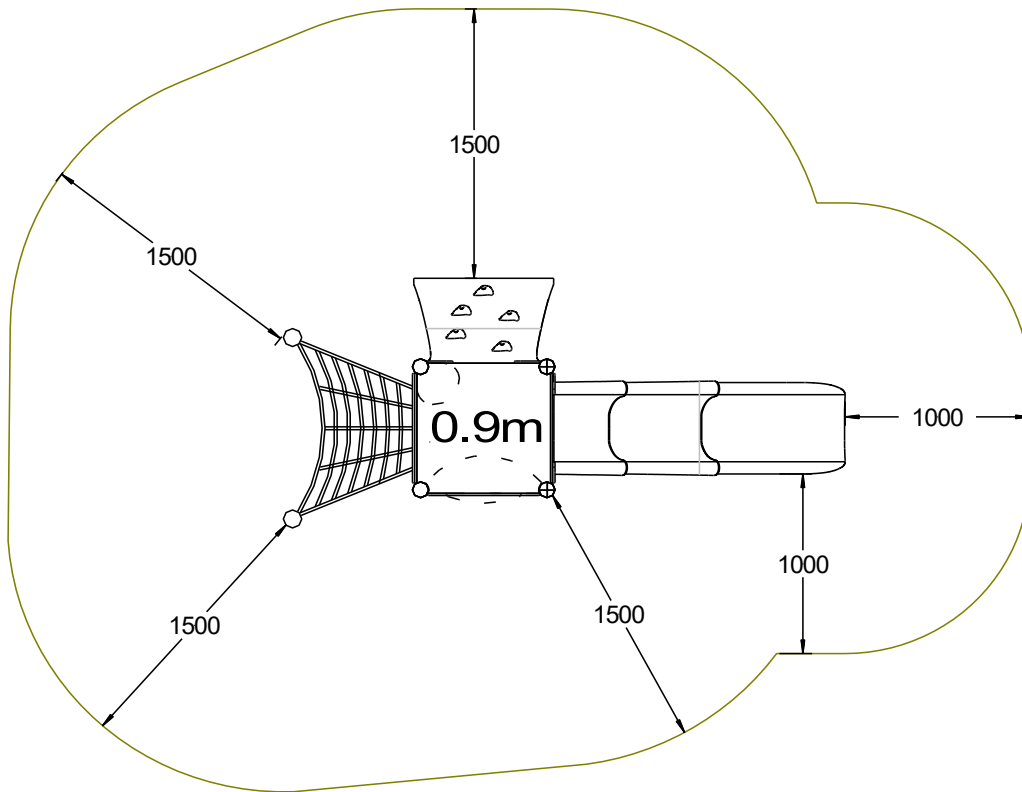

Stainless Steel Slide

