

1630

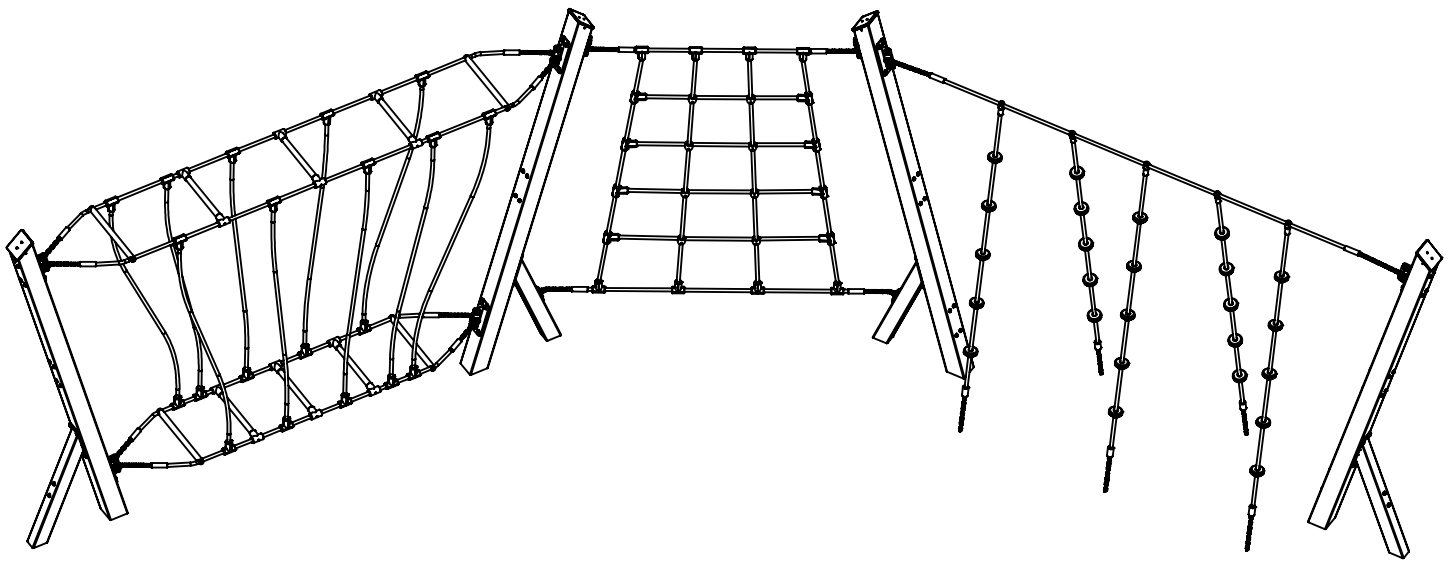

v012
20.10.2021
A. D.
[cm]

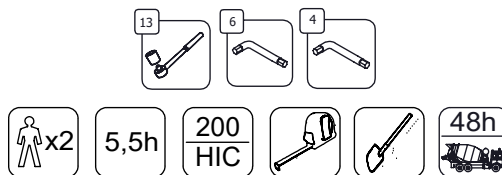

vinci
play

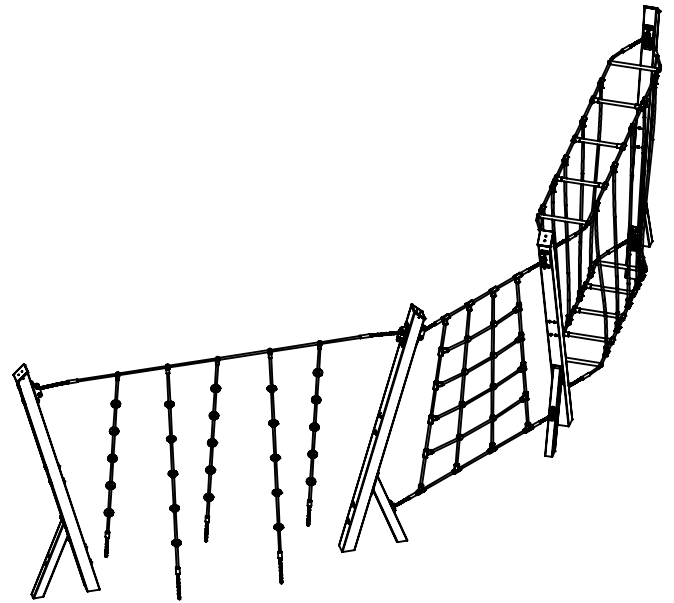
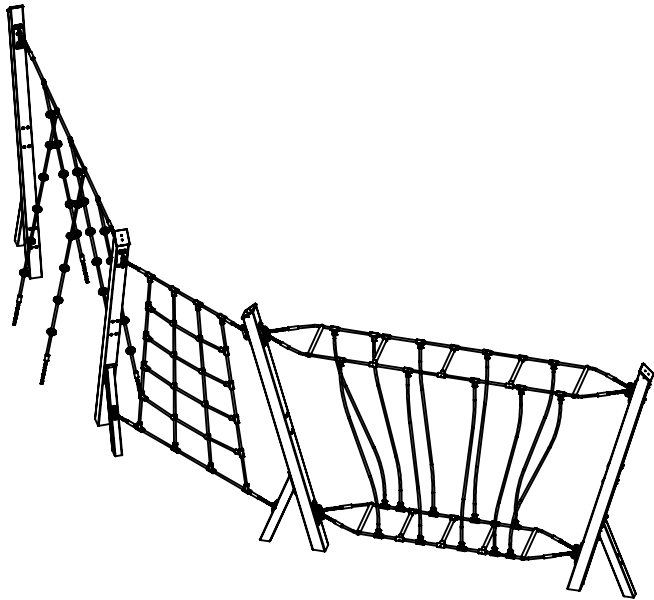
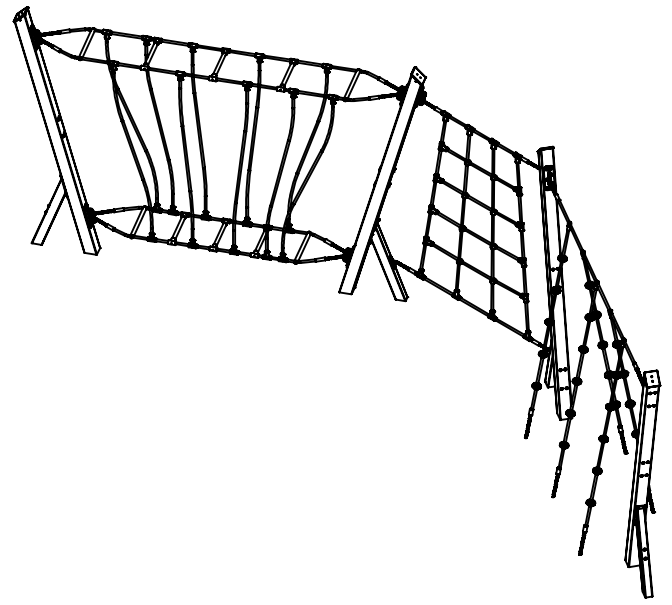
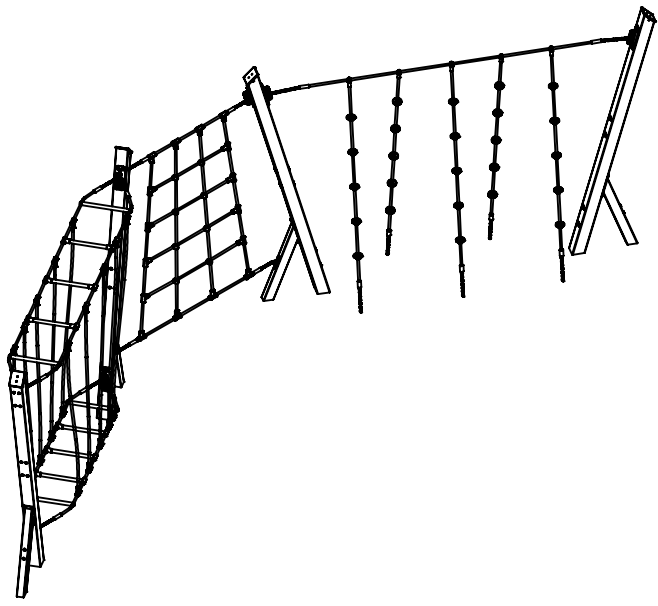

[cm]

vinci
play

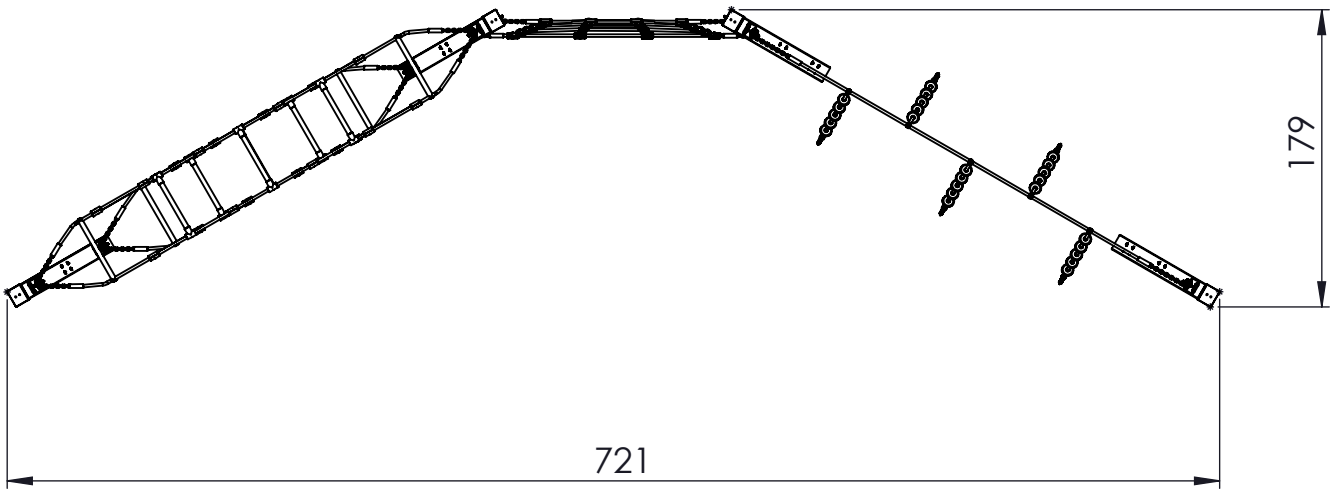
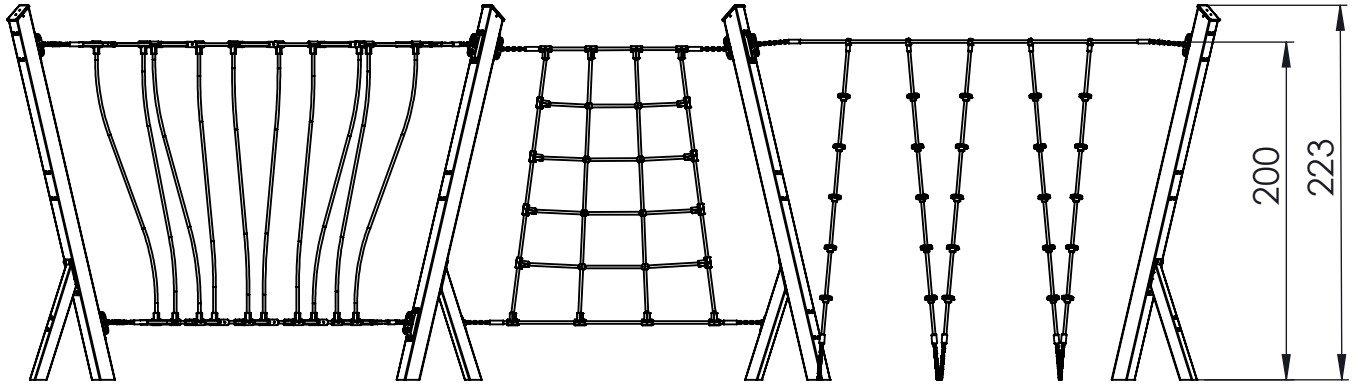

[cm]

vinci
play

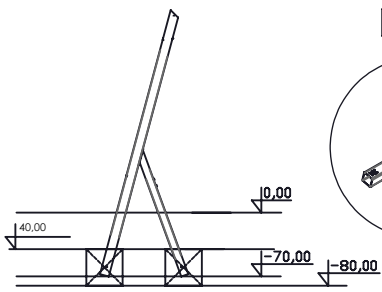

E90

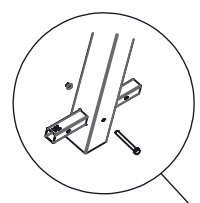

E1

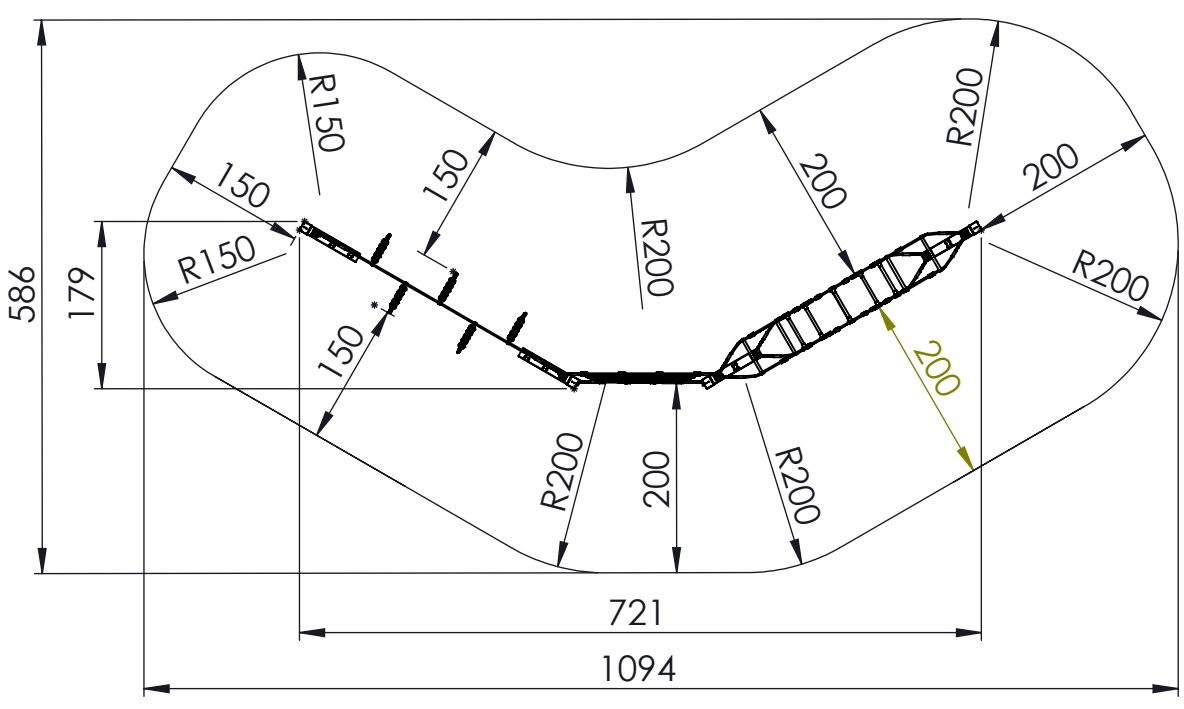
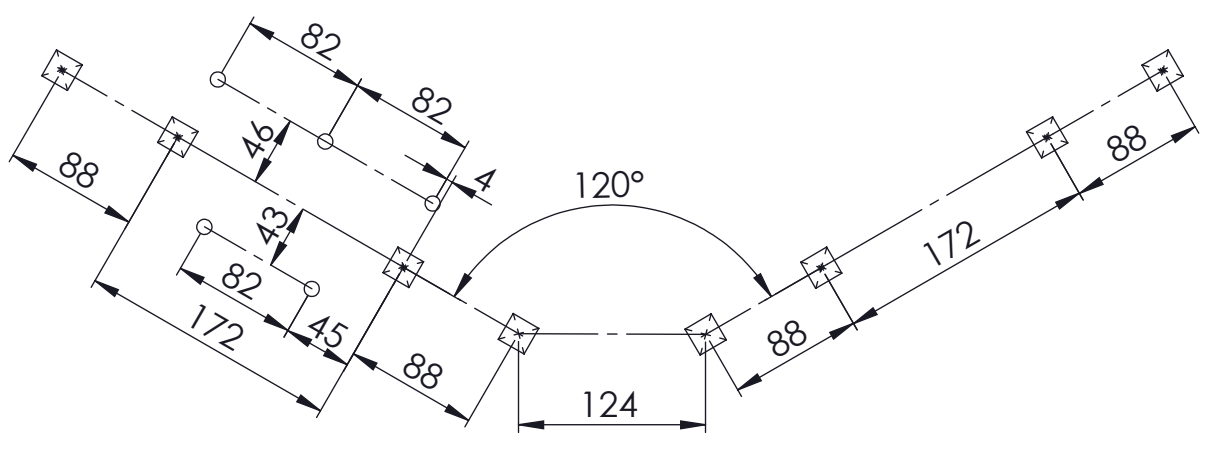
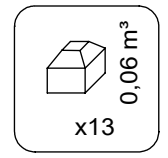
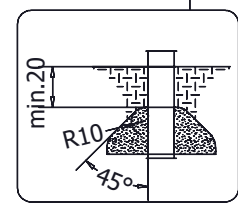
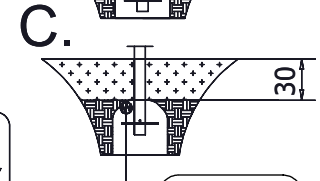
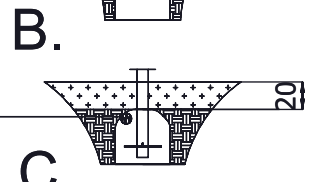
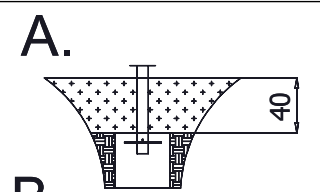
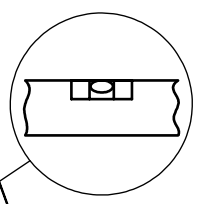
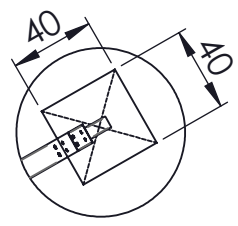
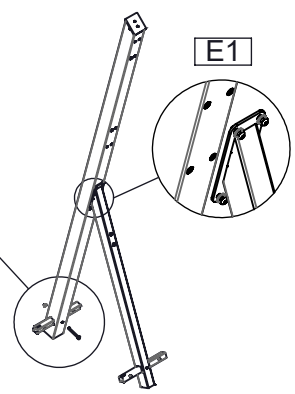

[cm]

vinci play

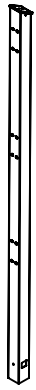

162100
x4



162100
x4

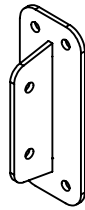

162101
x8

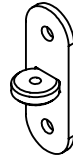

162102
x12



162103
x2

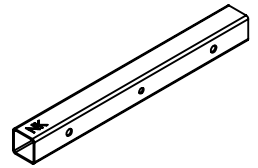

NK_kotw_1
x8

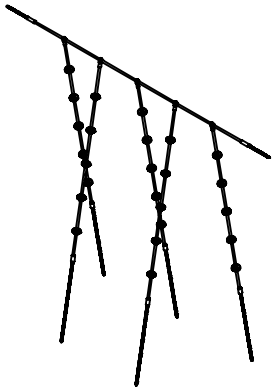

165102
x1

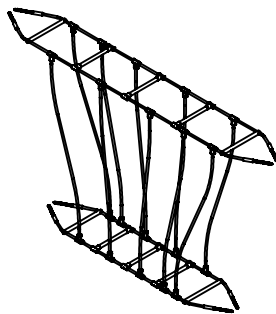

165105
x1

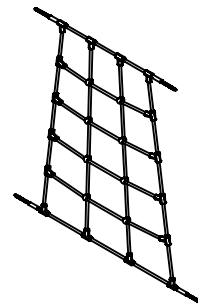

165111
x1

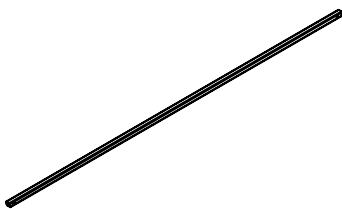

163100
x1

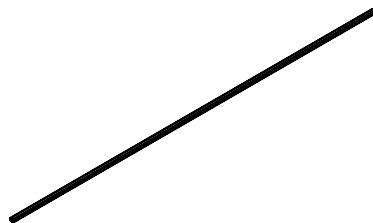

163101
x2

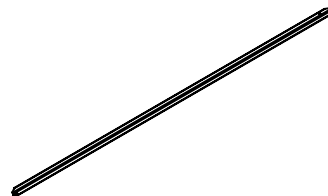

163103
x1

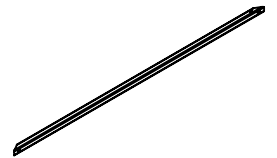

163104
x1

| | |
|-----|------|
| 12x | E1 |
| 4x | E90 |
| 4x | E91 |
| 3x | E92 |
| 13x | E93 |
| 2x | E94 |
| 2x | E96 |
| 1x | E97 |
| 5x | WD52 |
| 1x | V002 |

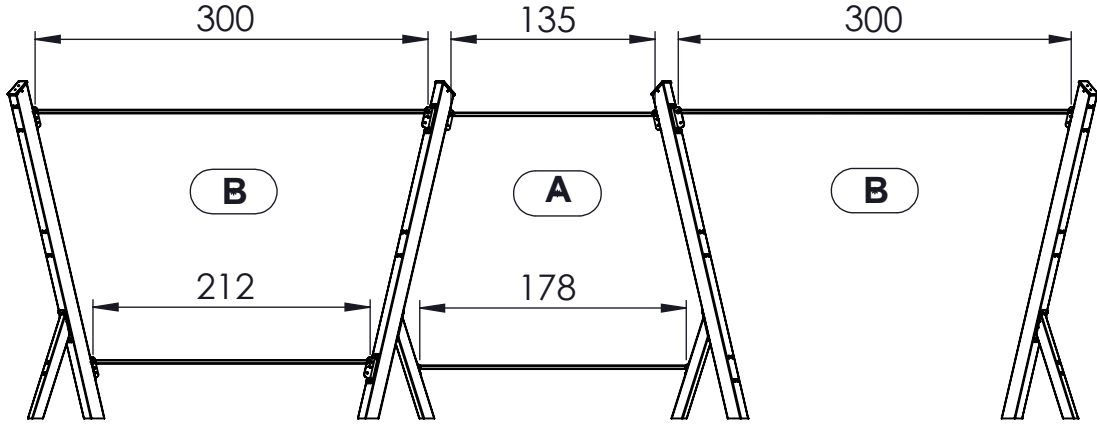
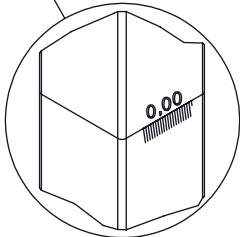
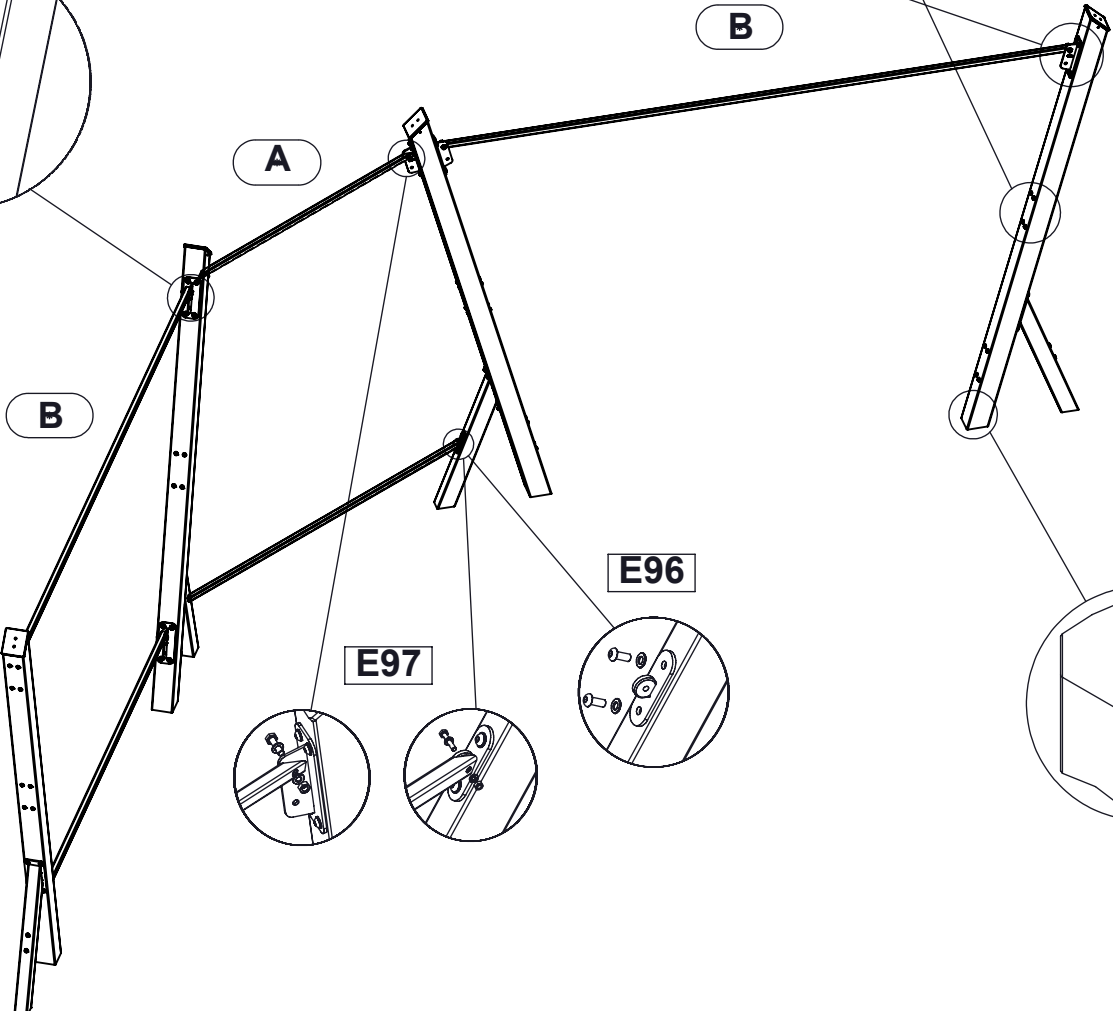
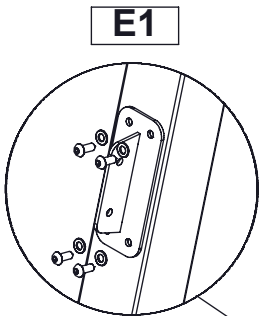
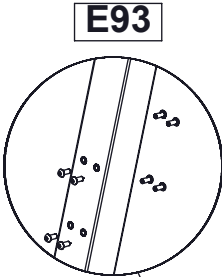
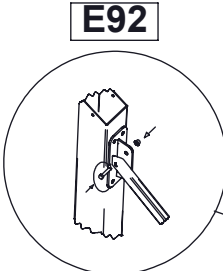
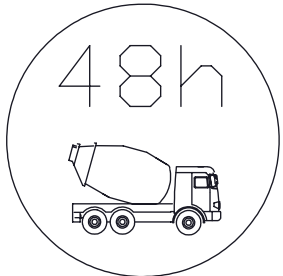

[cm]

vinci play

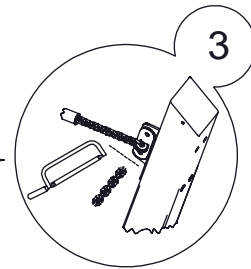
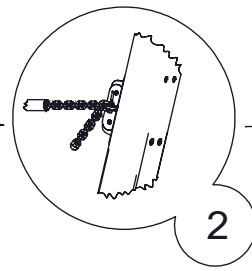
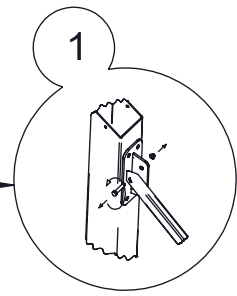
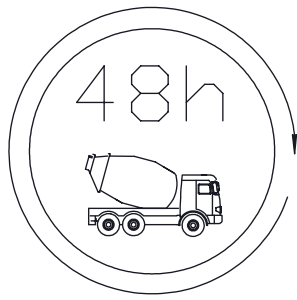

E91

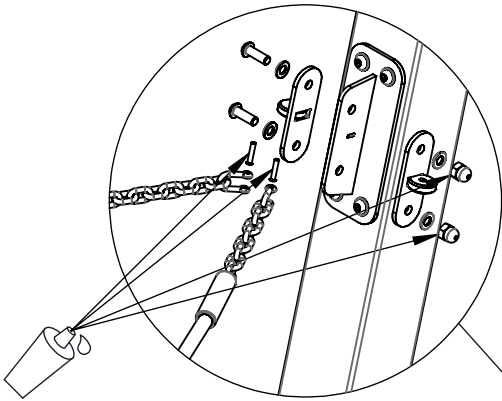

E94

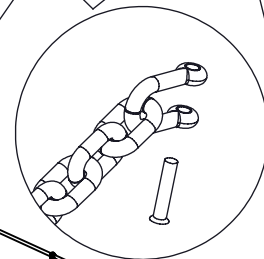
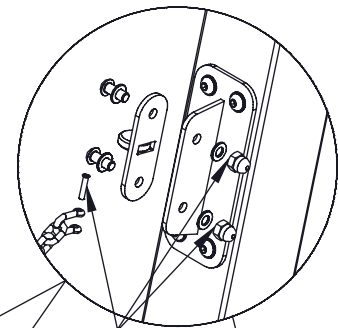

E96

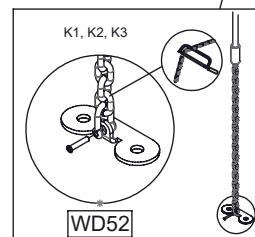
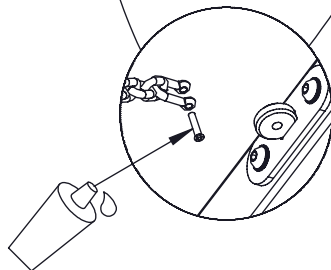

[cm]

vinci
play

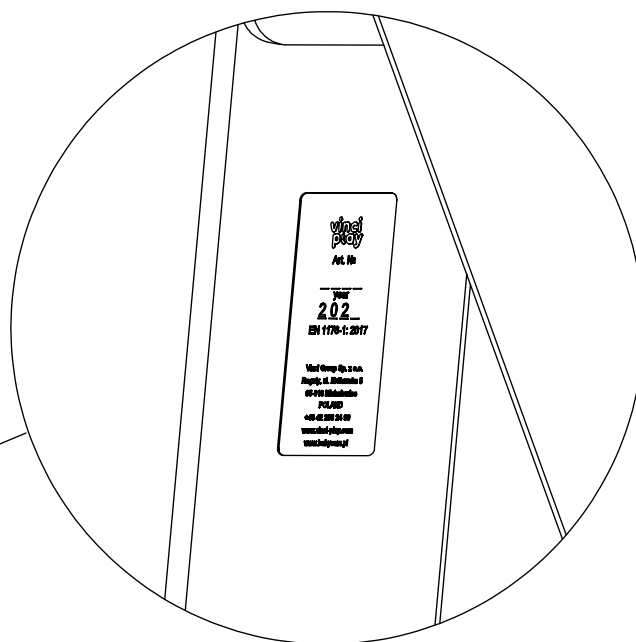
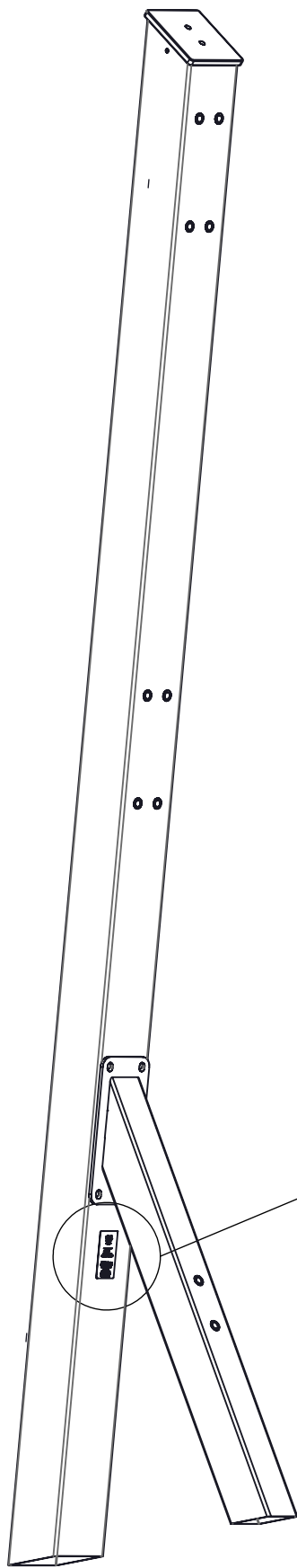

1x V002

[cm]

vinci
play