

# 1640

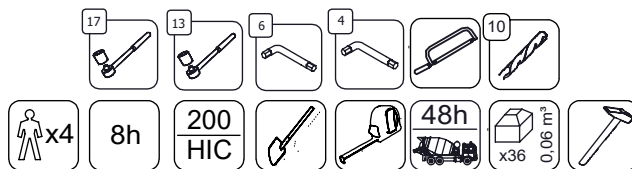

v012  
21.10.2021  
A. D.  
[cm]

vinci  
play

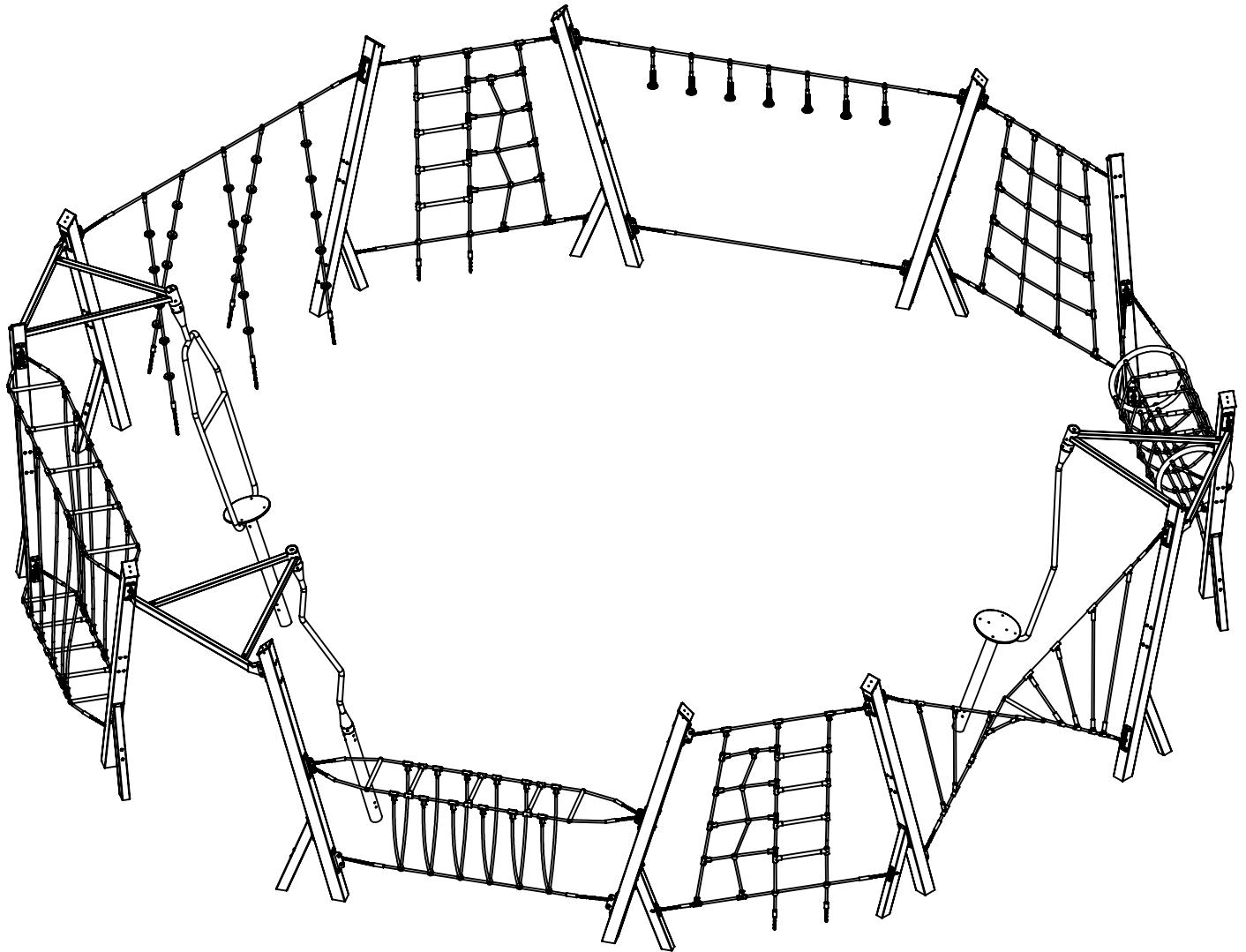
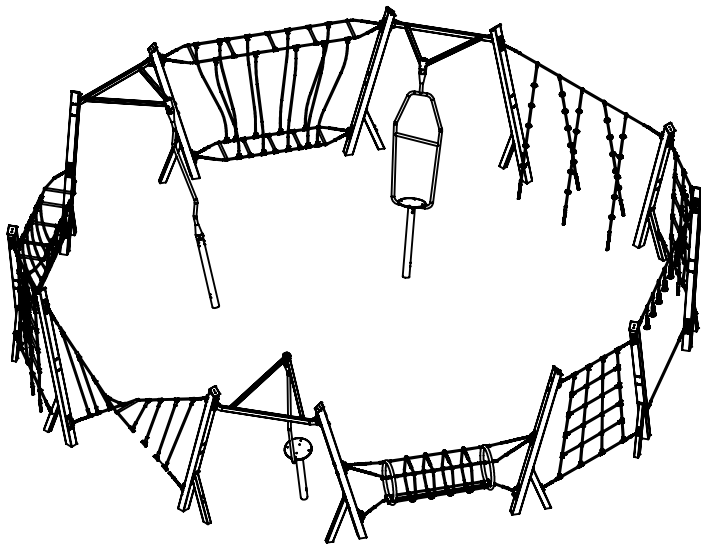
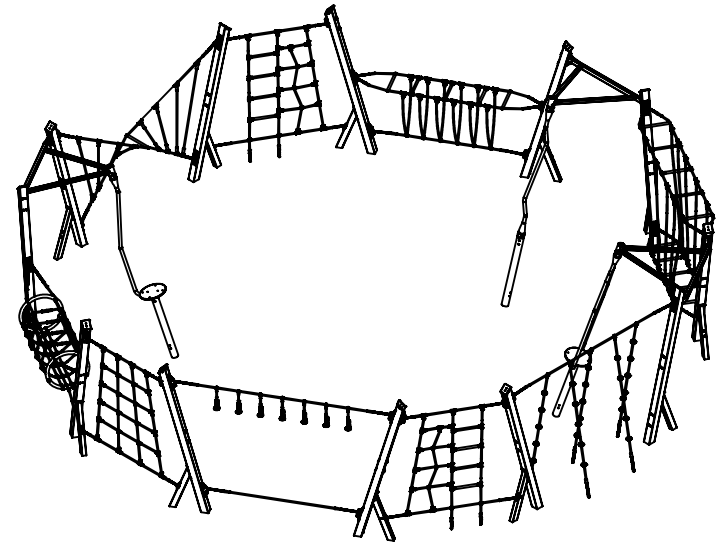
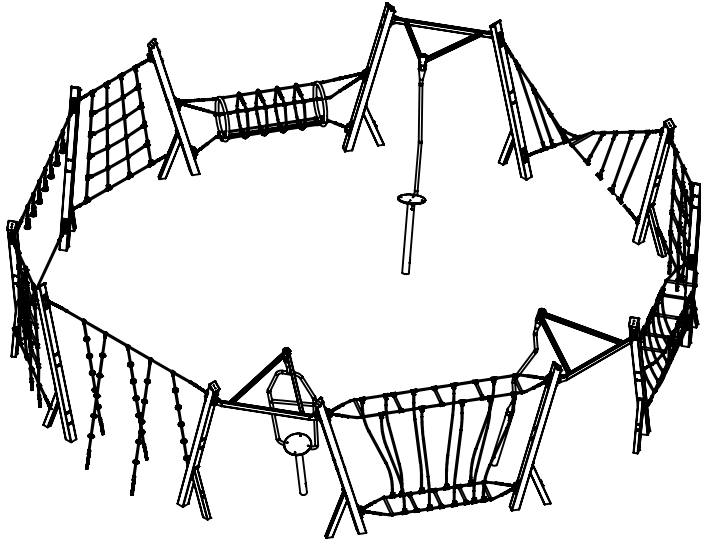
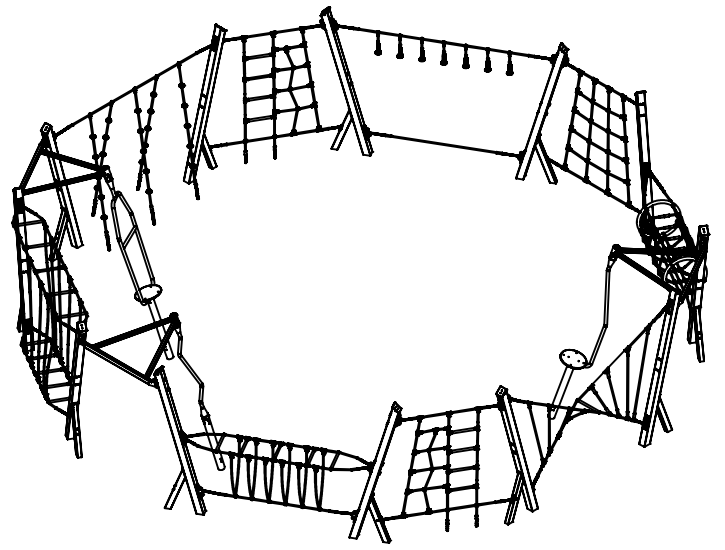

[cm]

vinci  
play

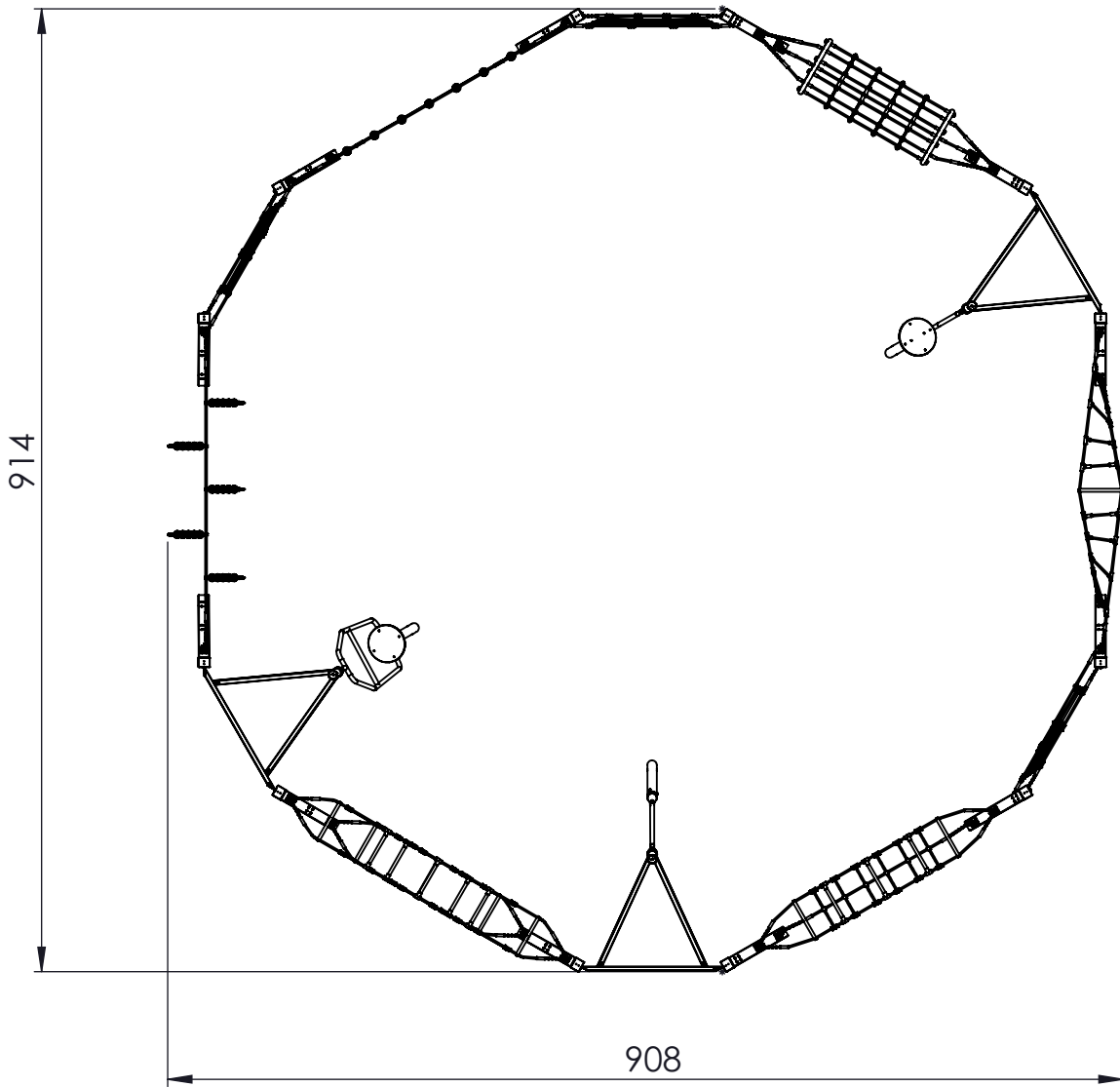
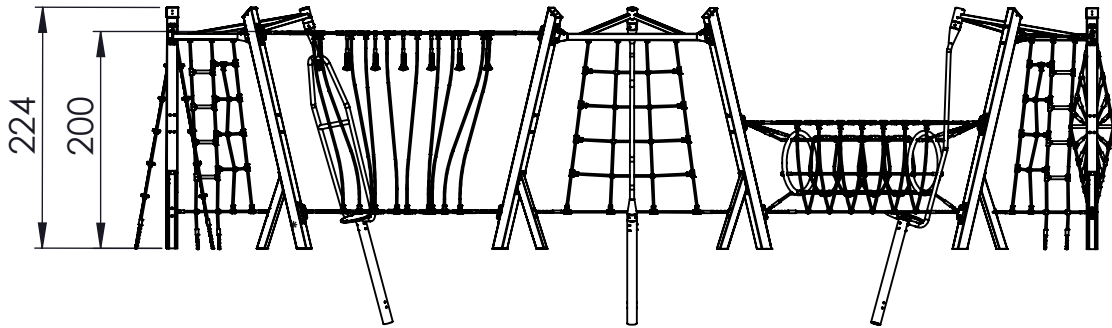

[cm]

vinci  
play

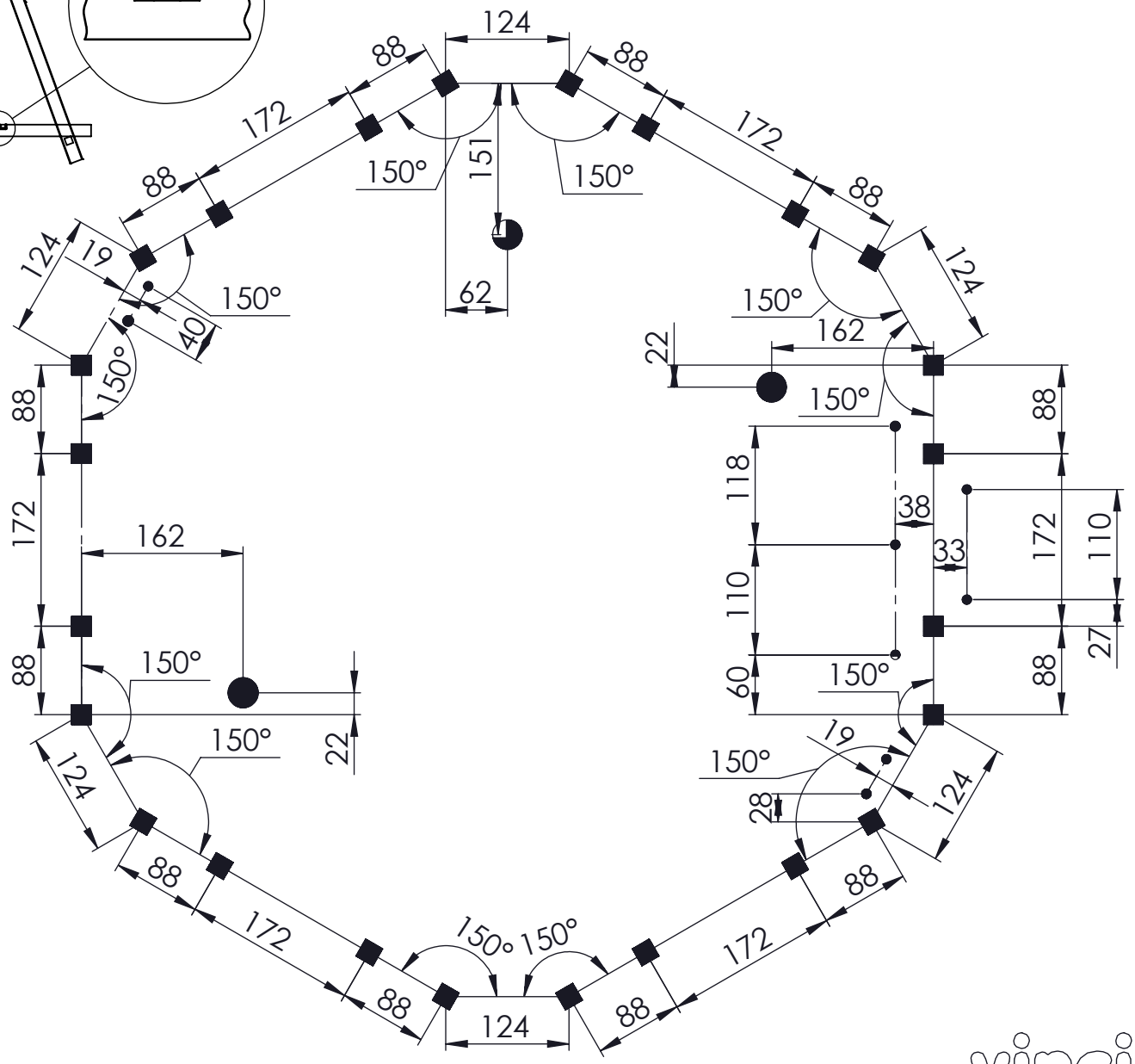
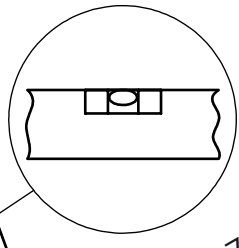
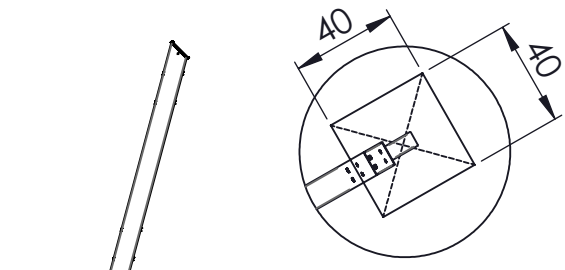
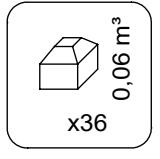
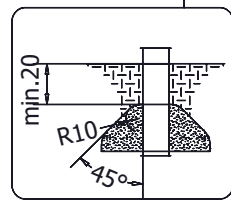
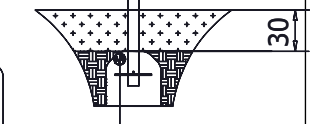
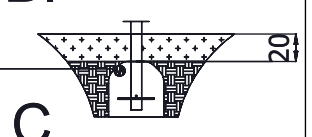
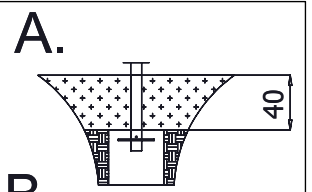
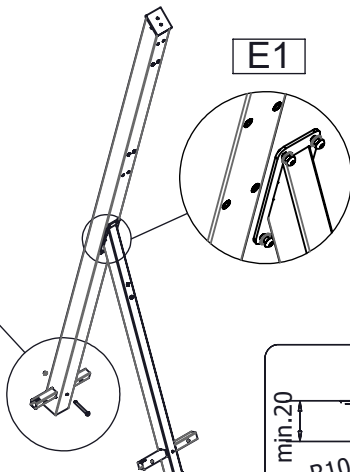
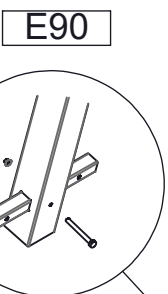
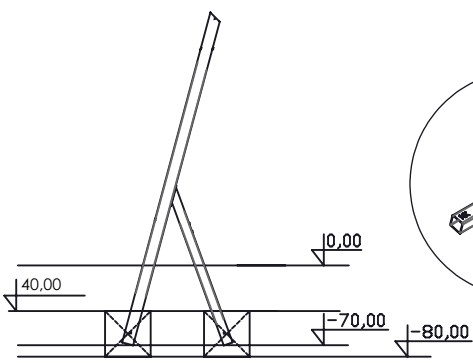

[cm]

x4   
 8h   
   
   
 x36 0,06 m³   
 48h

vinci play

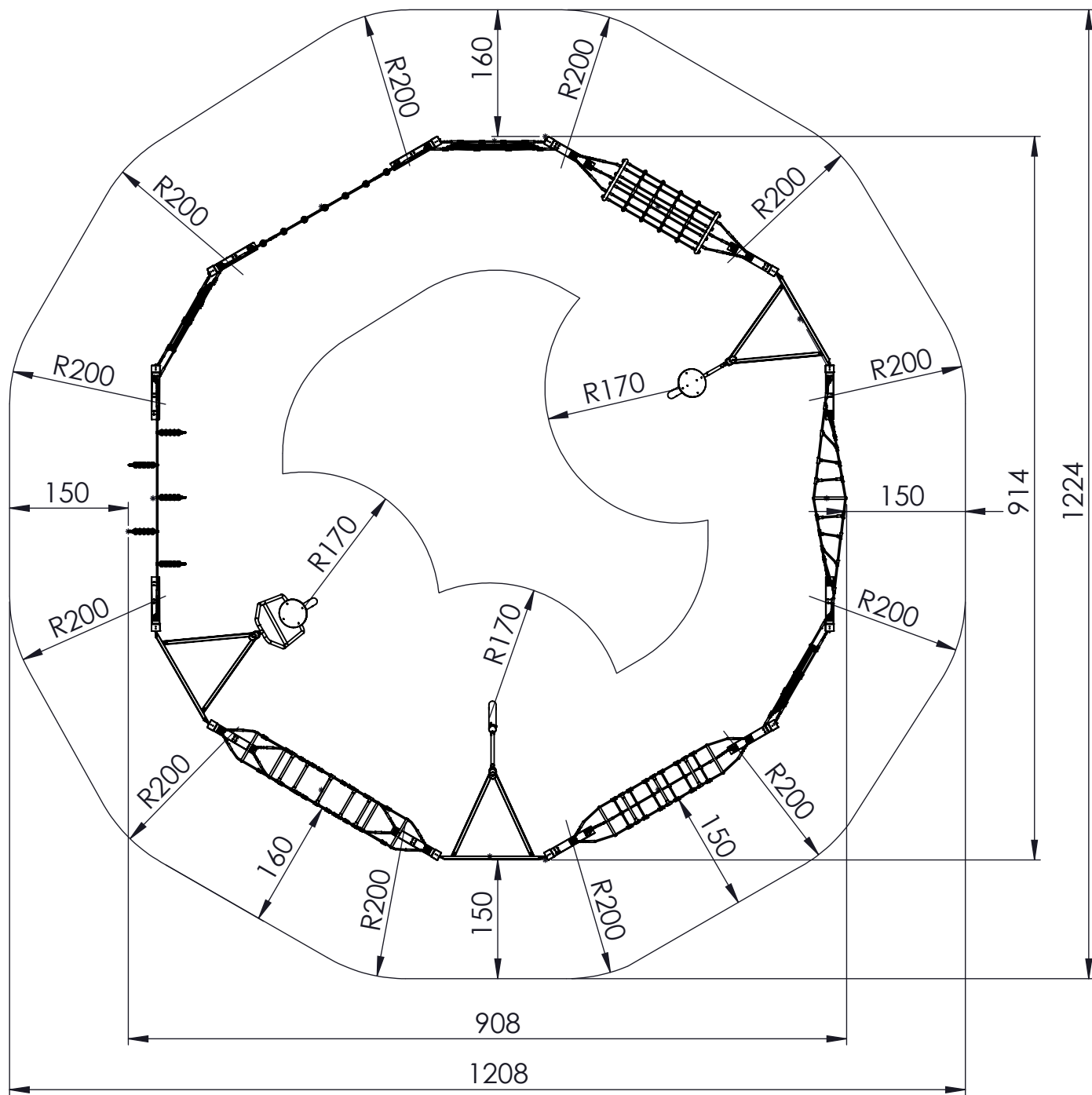

[cm]

vinci  
play

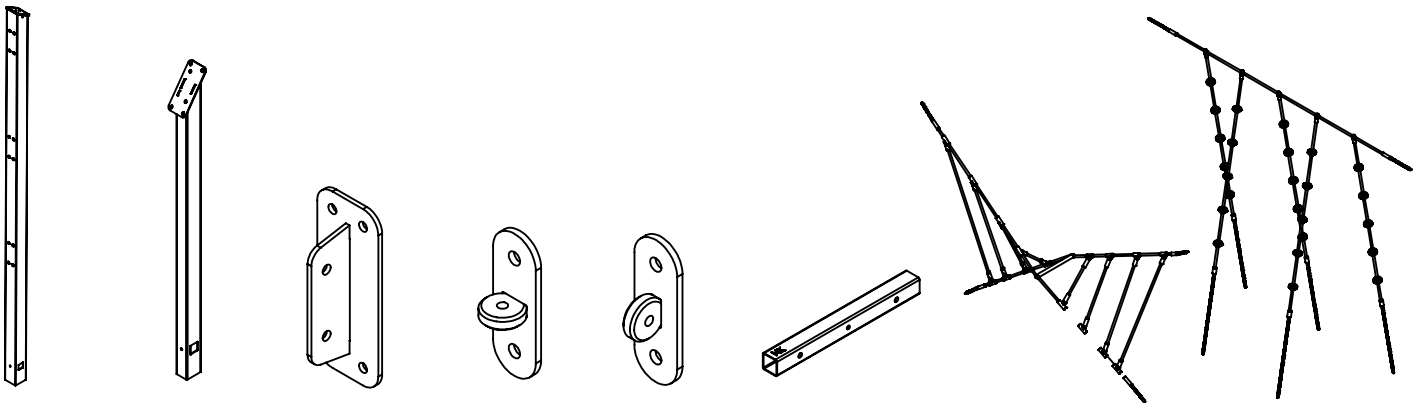

**164104** x12    **162100** x12    **162101** x34    **162102** x36    **162103** x6    **NK\_kotw\_1** x24    **165101** x1    **165102** x1

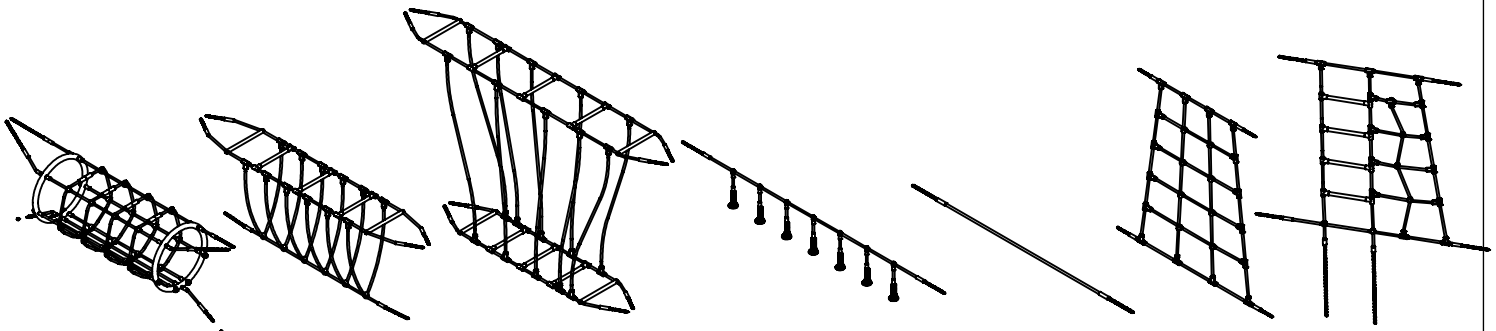

**165103** x1    **165104** x1    **165105** x1    **165108** x1    **165116** x1    **165111** x1    **165112** x2

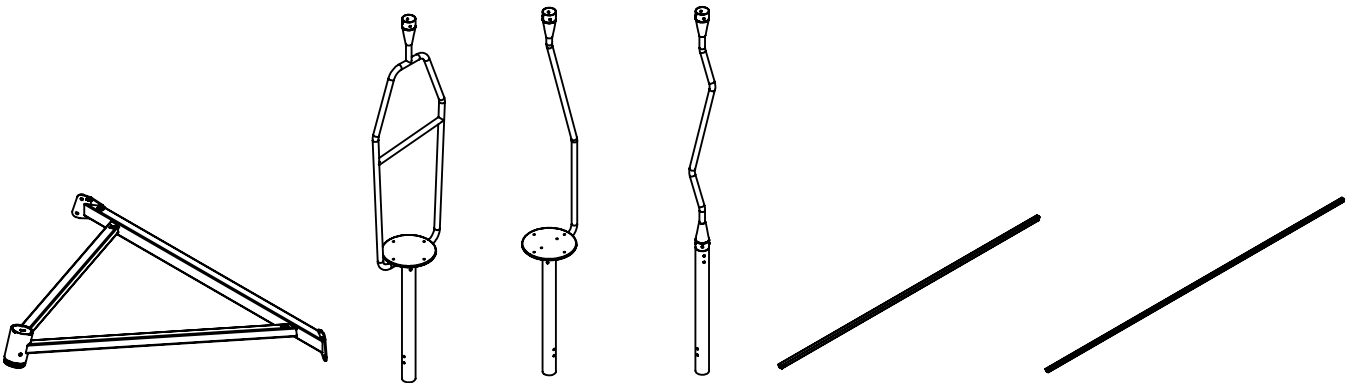

**164100** x3    **164101** x1    **164102** x1    **164103** x1    **163100** x5    **163101** x4

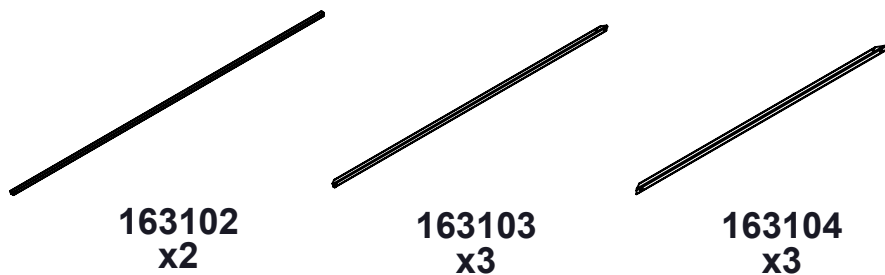

**163102** x2    **163103** x3    **163104** x3

10x	E94
48x	E1
12x	E90
11x	E92
8x	E91
29x	E93
3x	E74
3x	E95
3x	E97
6x	E96
9x	WD52
1x	V002

[cm]

vinci  
play

E95

E1

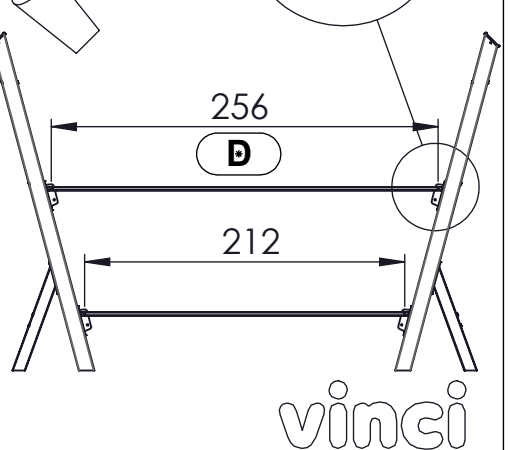
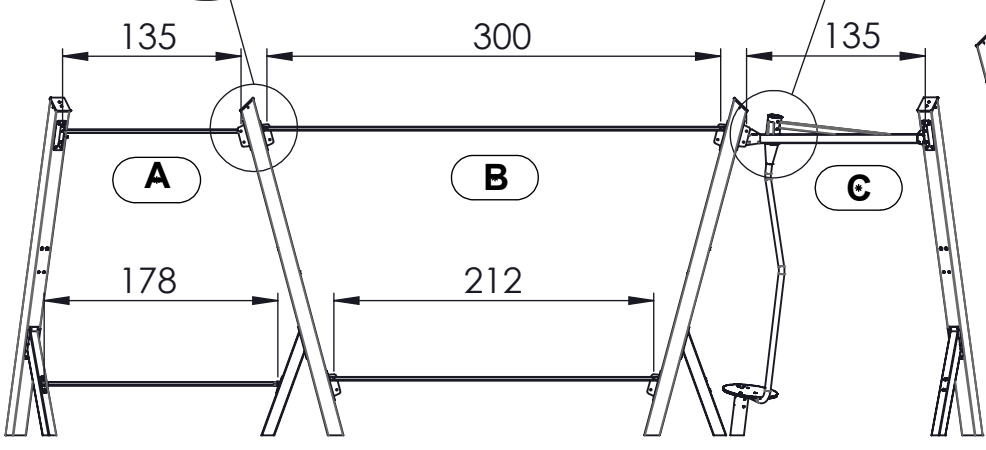
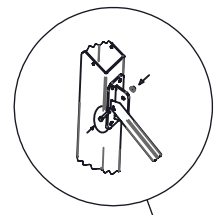
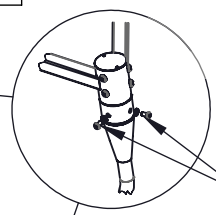
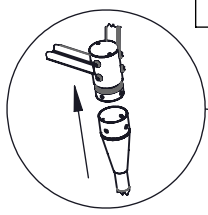
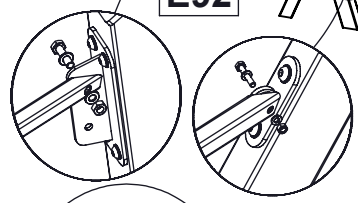
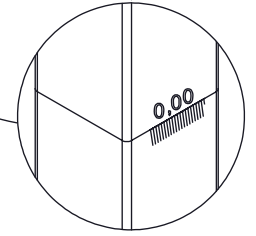
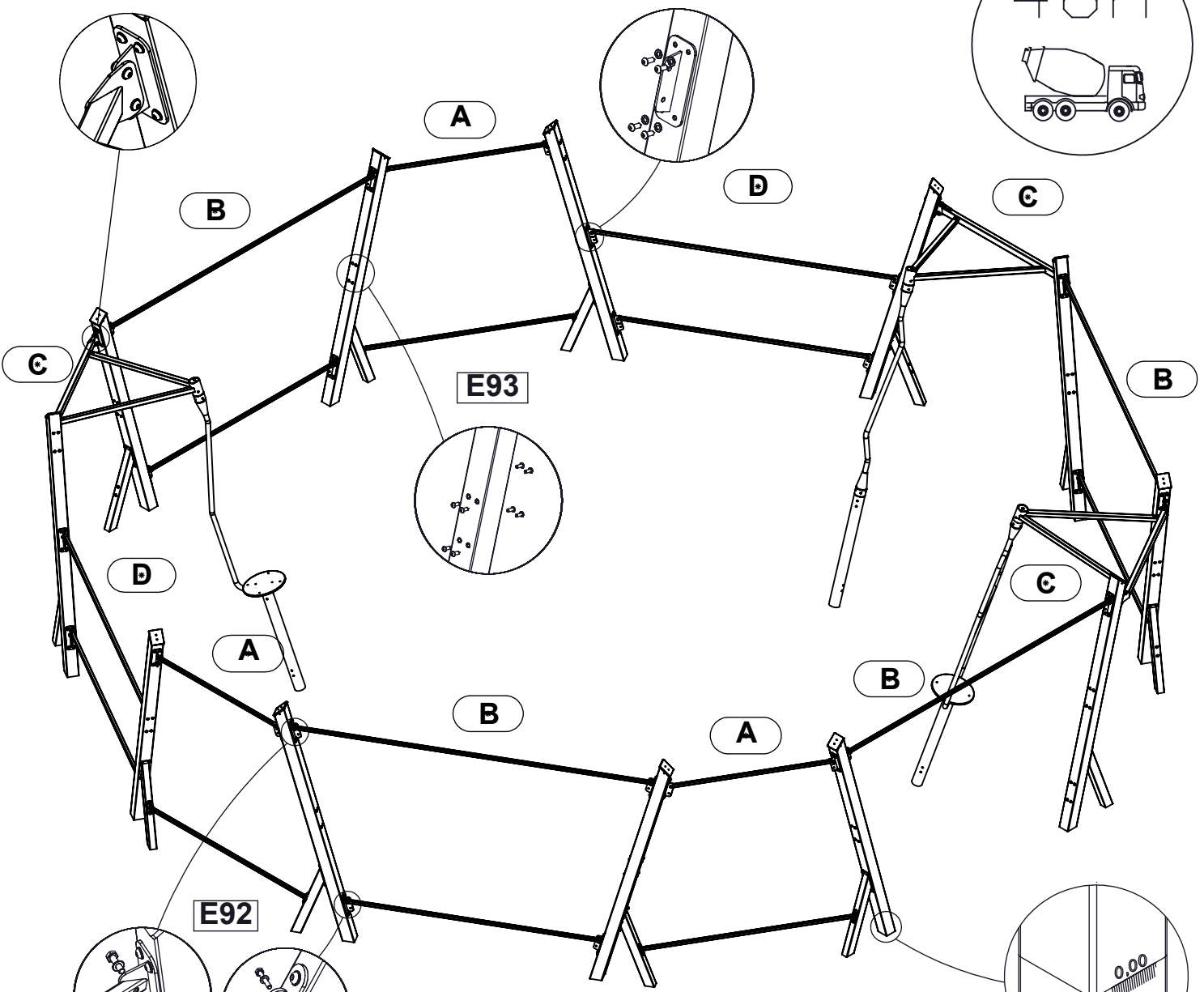

[cm]

vinci play

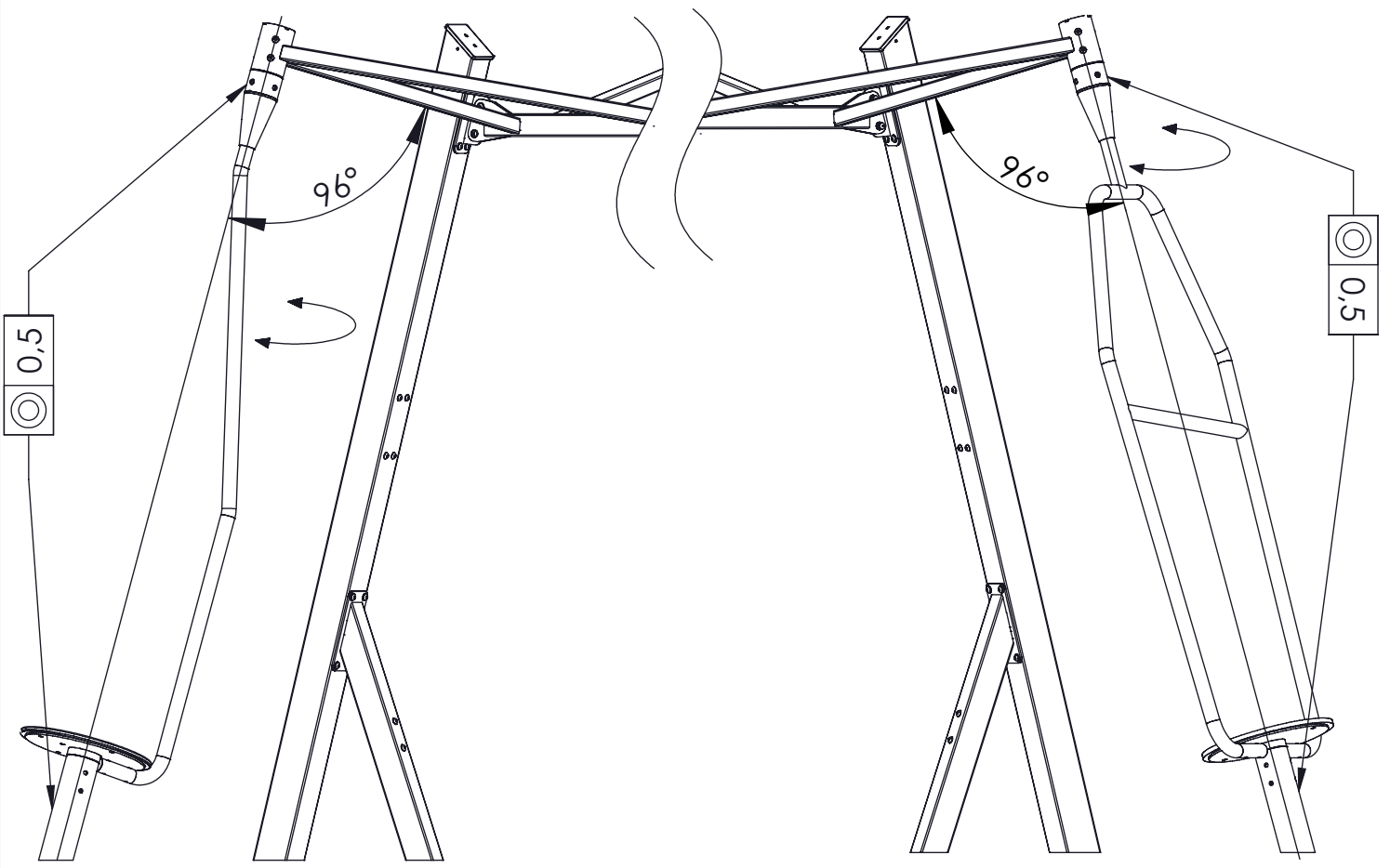
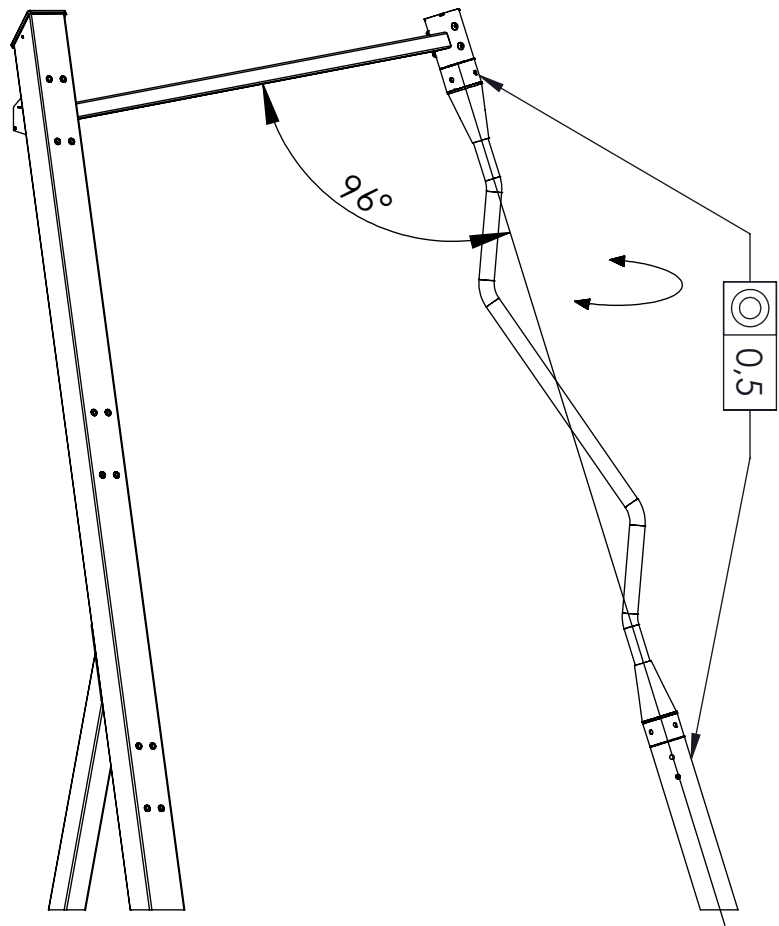

[cm]

vinci  
play



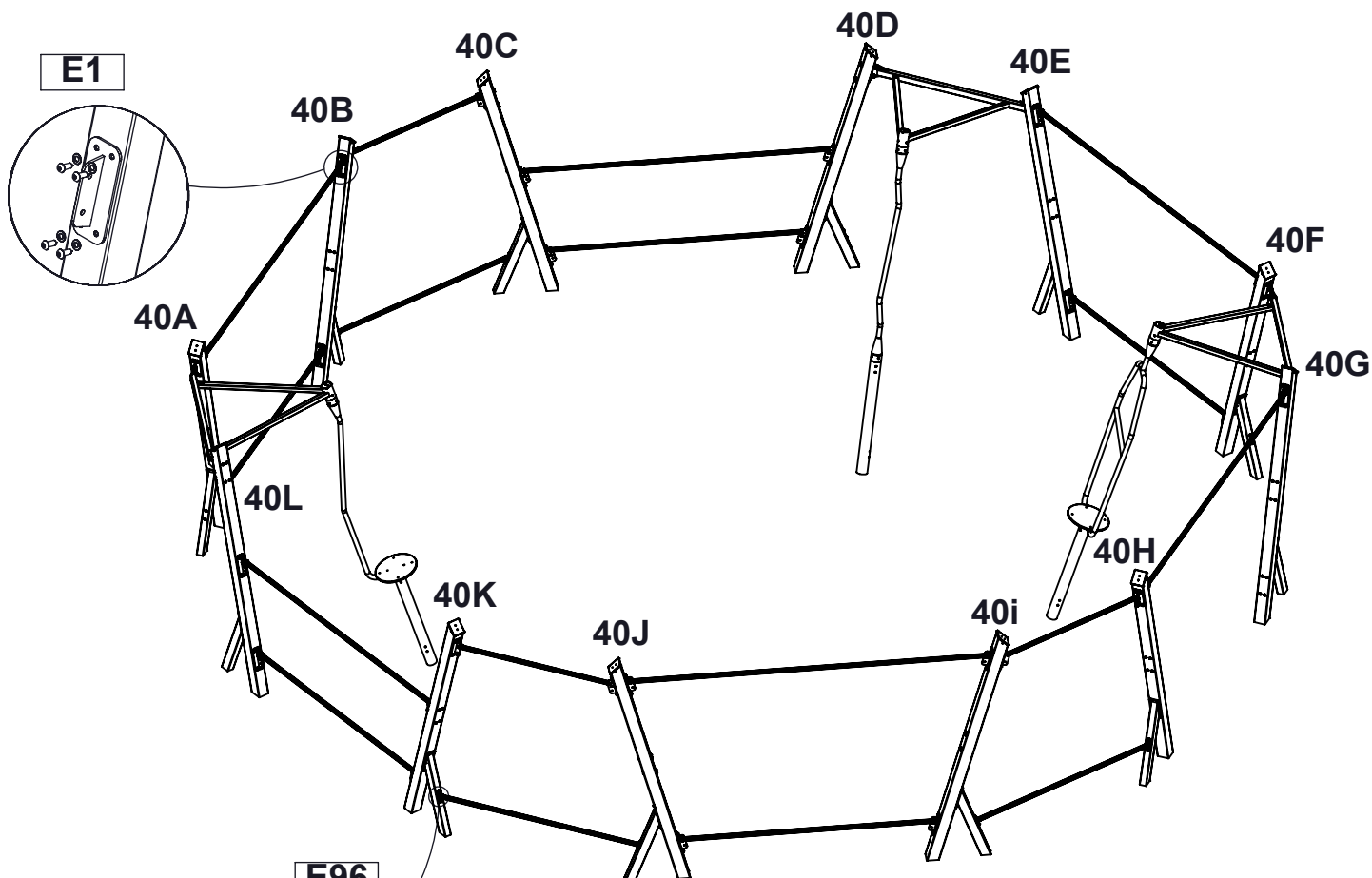

E96

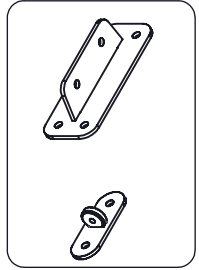
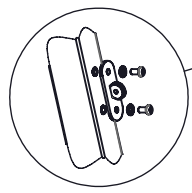
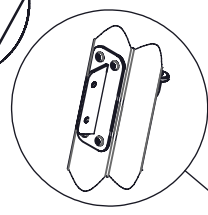
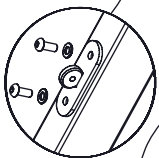

6

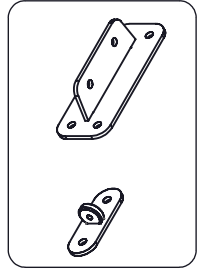

8

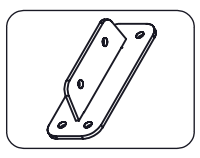

6

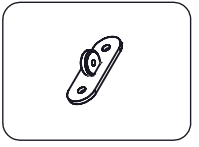
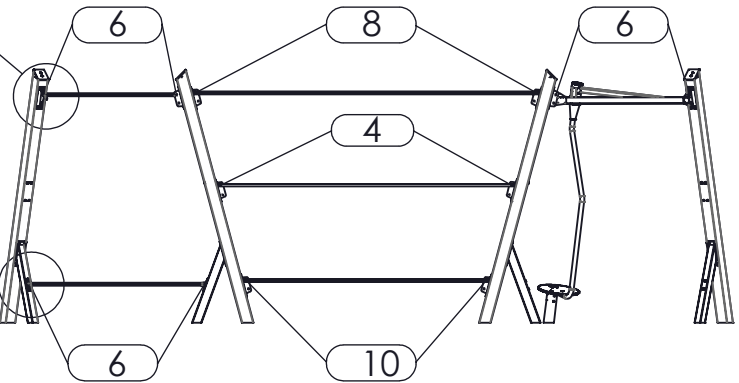

6

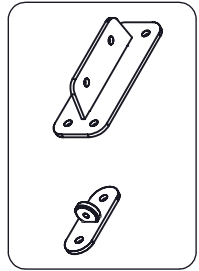

10

[cm]

vinci play

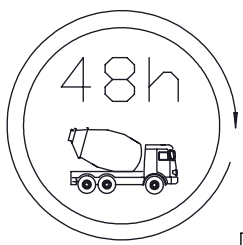

**E94**

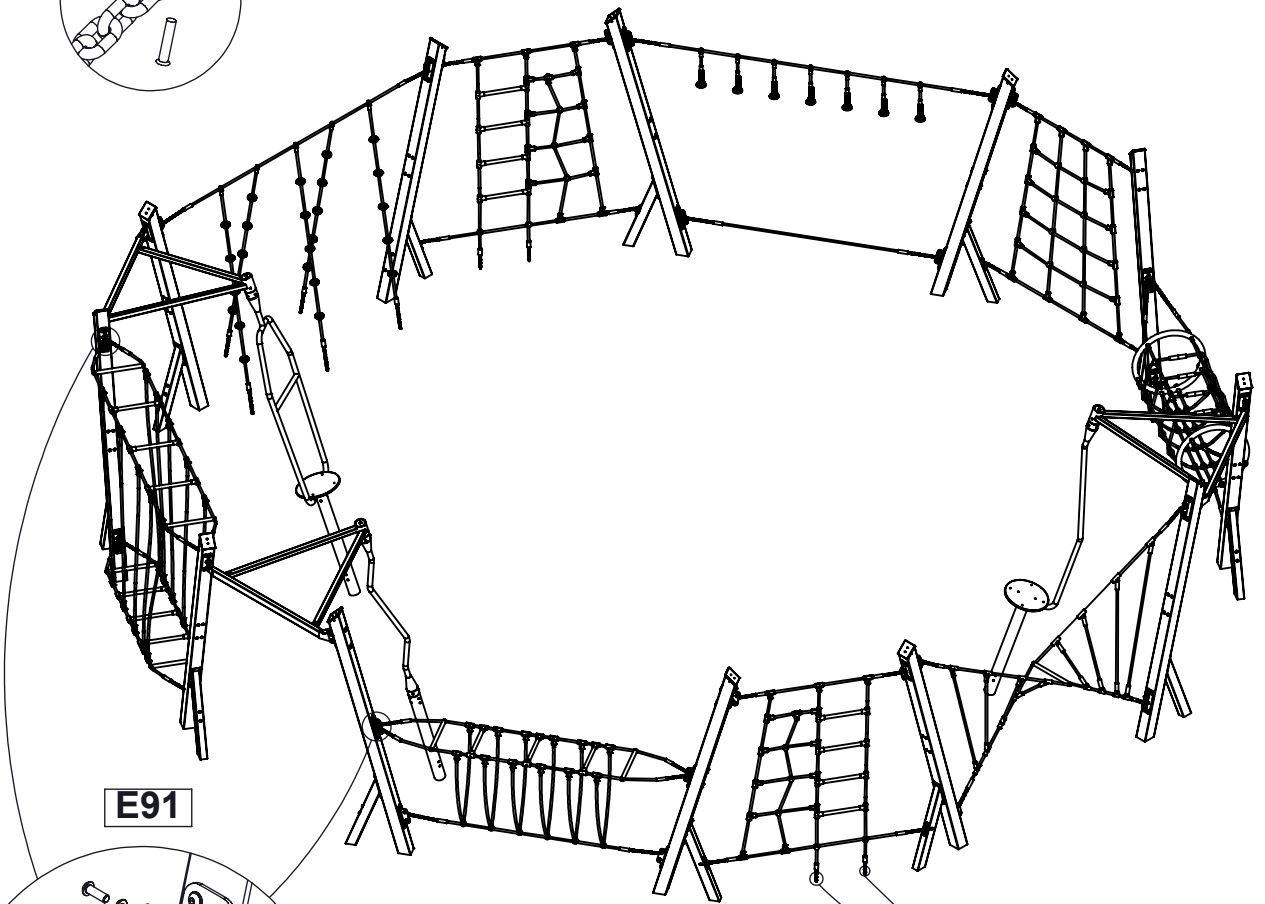
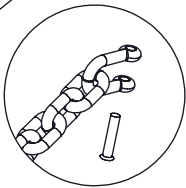
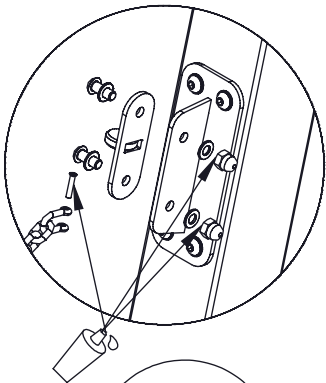
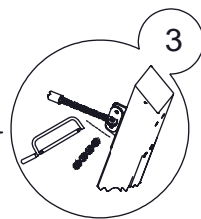
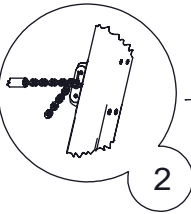
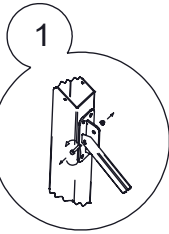

**E91**

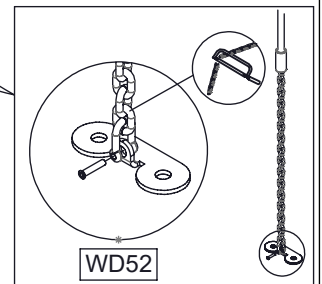
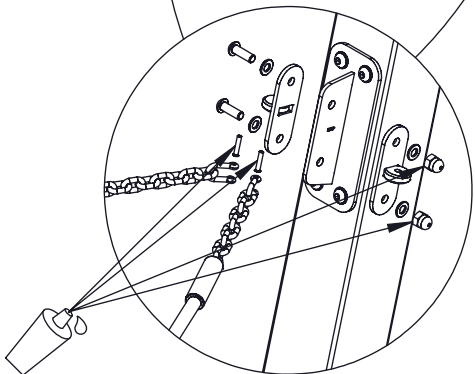

**WD52**

[cm]

vinci  
play

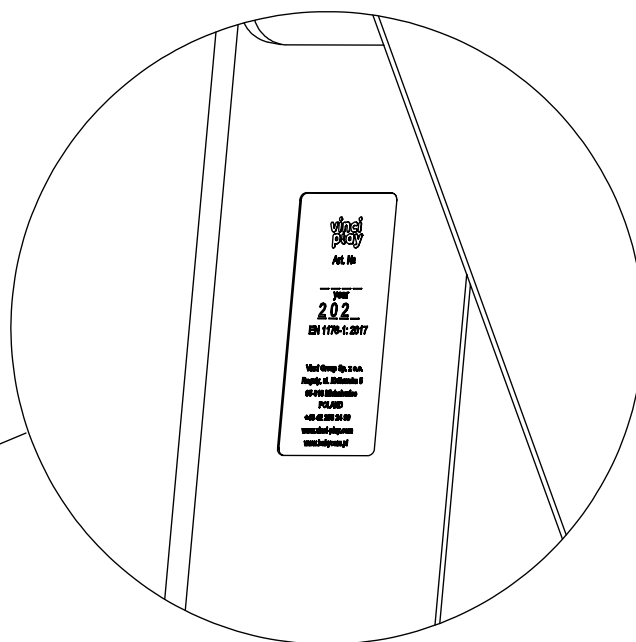
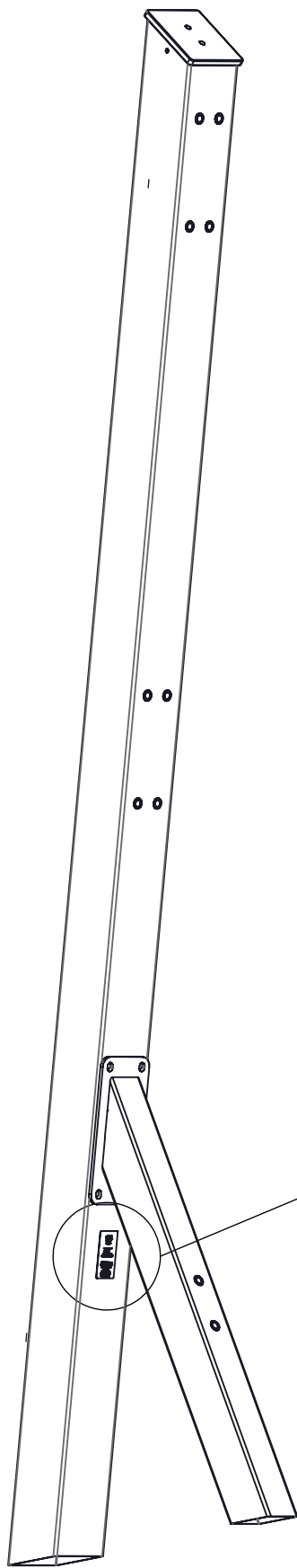

1x V002

[cm]

vinci  
play